

Spindle solutions

Spindle motors and motor spindles
for every requirement

Brochure · October 2009

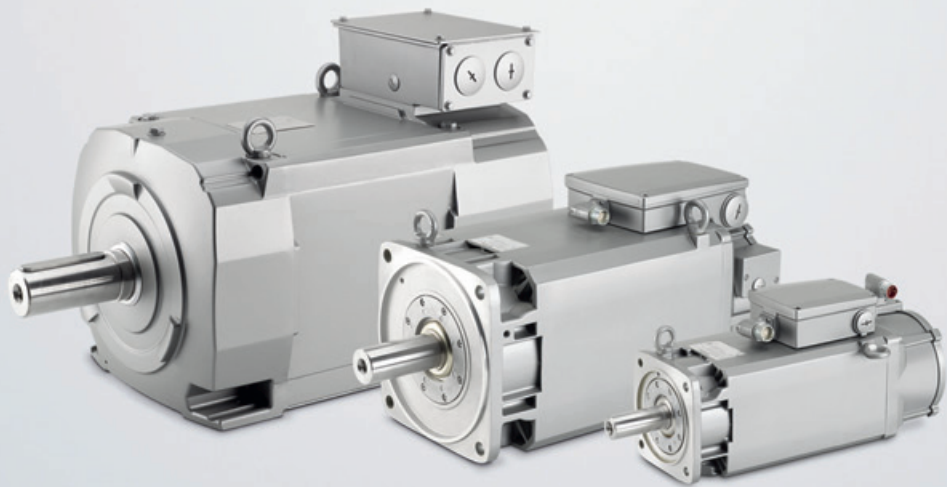
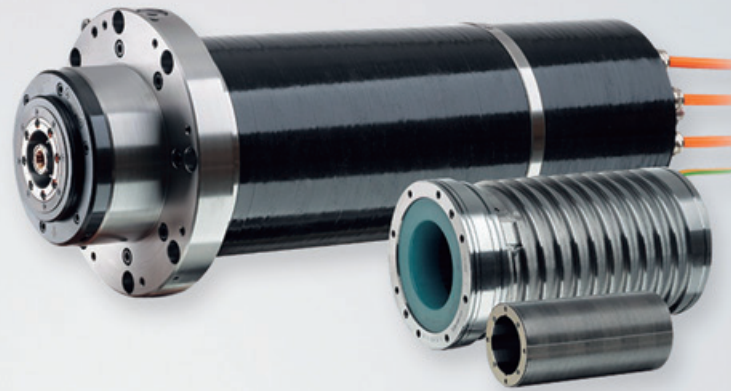

Motors

Answers for industry.

SIEMENS

The right spindle solution for any task

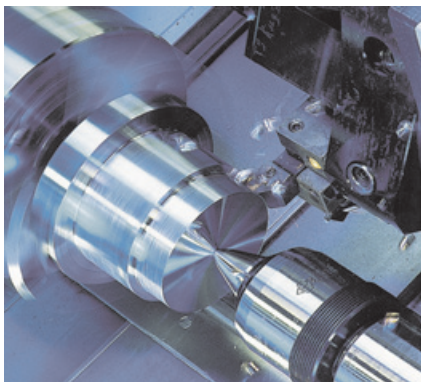

The function, performance and accuracy of the electrical and mechanical components used are the deciding factors for productivity and the quality of the output from machines and systems – not to mention the mechanical execution of the task.

Therefore, when it comes to machine tools, the functionality and performance of the CNC are crucial, as are the performance capabilities of the drive system and the running characteristics and dynamic response of the motors used.

The quality of the drives for the feed axes determine the dimensional accuracy of the workpieces. The spindle also makes a decisive contribution to their surface quality.

From the controller to the motor, with its broad product range, Siemens can always offer the components that are needed to satisfy the performance and quality requirements of any machine. This freedom of choice applies no less to spindle applications.

For conventional, typically belt-driven or coupled machine tool spindles, asynchronous motors are available in different versions. Our product range also includes externally driven spindles. Compact motor spindles that are integrated in the machine are increasingly used to further increase efficiency in production. Here, too, Siemens has the right solution for the job. All activities relating to motor spindles and externally driven spindles are concentrated in our subsidiary, Weiss Spindeltechnologie GmbH, whose expertise ranks it as an international leader in the field of motor spindles for milling, turning and grinding.

With SINUMERIK as the machine tool control, SINAMICS S120 or SIMODRIVE as the drive system and our feed and spindle motors, Siemens is capable of offering complete solutions for every machine type and performance class – solutions in which the components are ideally harmonized to ensure high productivity, high availability and optimum quality.

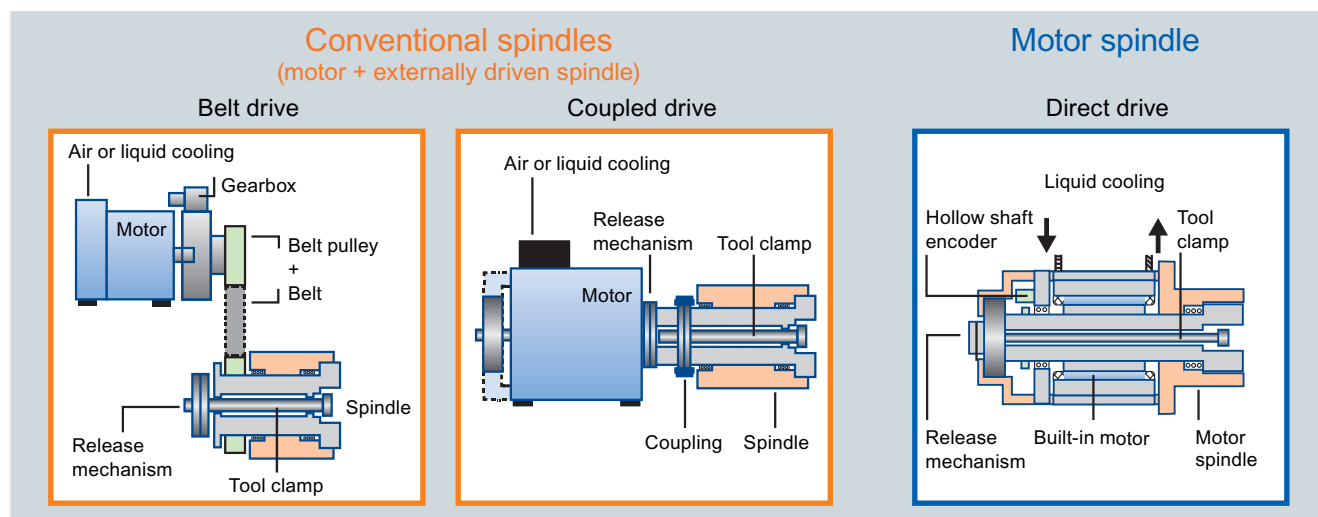

Main spindle drive variants – Overview

Topological overview

Motors and spindles for machine tools

Siemens is an experienced and competent complete equipper of machine tools. On the basis of the SINUMERIK numerical control, the SINAMICS S120 or SIMODRIVE 611 drive system and our extensive range of motors for feed drives and main drives,

extending to integrated motor spindles, Siemens is in a position to offer suitable electrical equipment with perfectly matched system components for every type of machine tool.

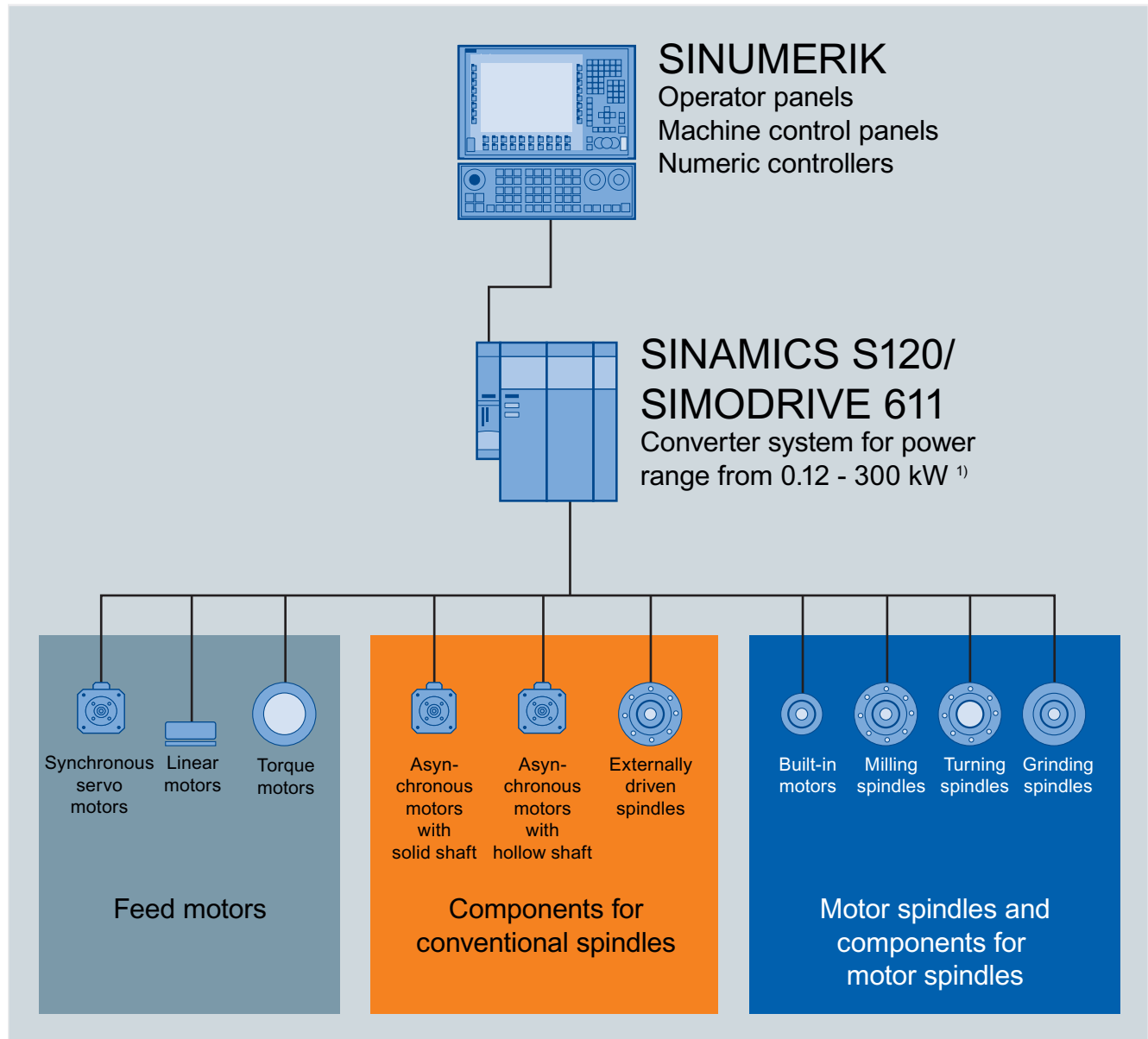

Siemens range of components for equipping machine tools

¹⁾ In combination with SINAMICS S120 & SINUMERIK.

Components for conventional spindles

Overview

Component	Type	Version	Max. speed	Rated power	Rated torque	Page	Catalog
Motors for belt-driven spindles							
	1PH8	Asynchronous motor with solid shaft, water-cooled, IP55/IP65	up to 20,000 rpm	2.8 ... 227 kW	14 ... 2,589 kW	7	NC 61
	1PH8	Asynchronous motor with solid shaft and forced ventilation, IP23/IP55	up to 20,000 rpm	2.8 ... 29 kW	13 ... 162 kW	7	NC 61
	1PH7	Asynchronous motor with solid shaft and forced ventilation, IP54/IP55	up to 12,000 rpm	3.7 ... 205 kW ¹⁾	22 ... 1,080 Nm	7	NC 60, NC 61
	1PH4	Asynchronous motor with solid shaft, water-cooled, IP55/IP65	up to 12,000 rpm	7.5 ... 52 kW ¹⁾	45 ... 333 Nm	7	NC 60, NC 61
Motors with hollow shaft for coupled spindles							
	1PH8 water-cooled	Asynchronous motor with hollow shaft, water-cooled, IP55/IP65	up to 20,000 rpm	3.5 ... 29 kW	14 ... 140 Nm	7	NC 61
	1PH8 forced ventilation	Asynchronous motor with solid shaft and forced ventilation, IP23/IP55	up to 20,000 rpm	2.8 ... 29 kW	10 ... 162 Nm	7	NC 61
Externally driven spindles							
	M series	Externally driven spindles for milling with SK40/BT40/CAT40 tool interface	up to 15,000 rpm	up to 27 kW	up to 140 Nm	11	–

NC 60: Catalog "Automation Systems for Machine Tools – SINUMERIK & SIMODRIVE"

NC 61: Catalog "Machine Tool Equipment – SINUMERIK & SINAMICS S120"

¹⁾ In combination with SINAMICS S120 & SINUMERIK.

Built-in motors and motor spindles

Overview

Component	Type	Version	Max. speed	Rated power	Rated torque	Page	Catalog	
Built-in motors for motor spindles								
Built-in motors		1PH2	Built-in asynchronous motor for standard spindles	up to 10,000 rpm	7.5 ... 31 kW	48 ... 197 Nm	14	NC 60 NC 61
		1FE1 (High Speed)	Built-in synchronous motor for spindles with top speeds	up to 40,000 rpm	6 ... 94 kW	up to 300 Nm	14	NC 60 NC 61
		1FE1 (High Torque)	Built-in synchronous motor for spindles with maximum torques	up to 20,000 rpm	4 ... 103 kW	up to 820 Nm	14	NC 60 NC 61
Motor spindles								
Motor spindles		2SP1 series	Standard motor milling spindles	up to 18,000 rpm	up to 53.4 kW	up to 170 Nm	19	NC 60 NC 61
		F series	Compact motor milling spindles	up to 40,000 rpm	up to 80 kW	up to 300 Nm	20	–
		D series	Motor lathe spindles	up to 10,500 rpm	up to 104 kW	up to 820 Nm	21	–
		S series	Motor grinding spindles	up to 80,000 rpm	up to 30 kW	up to 24 Nm	22	–

NC 60: Catalog "Automation Systems for Machine Tools – SINUMERIK & SIMODRIVE"

NC 61: Catalog "Machine Tool Equipment – SINUMERIK & SINAMICS S120"

Conventional spindles

Conventional spindles are the most popular type of spindle in machine tools. They are modular in design, comprising the externally driven spindle unit with tool/workpiece holder and the motor for driving the spindle.

There is a choice of two basic types. The motor and spindle are connected to one another either via a belt or via a coupling.

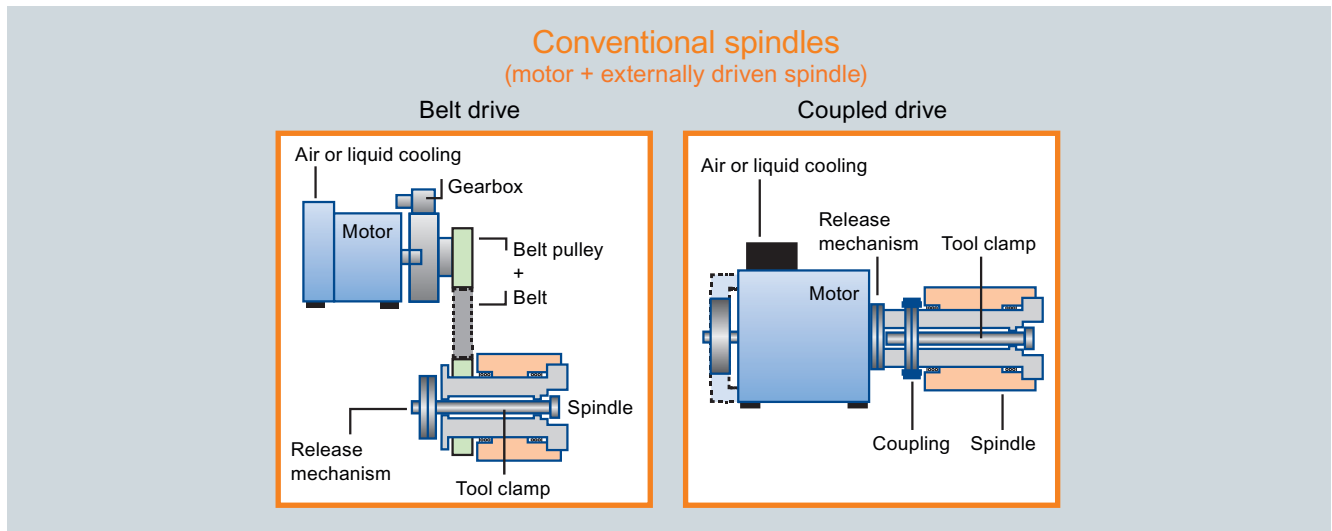

Conventional spindle designs

For conventional spindles, the Siemens product range contains different versions of asynchronous motors ranging from 2.8 to 286 kW¹⁾, and can therefore provide a suitable spindle motor for every machining technique – milling, turning or grinding. And complementing this range, Siemens can also offer mechanical spindles from Weiss Spindeltechnologie GmbH, a subsidiary 100%-owned by Siemens.

This gives the user the opportunity to purchase not just the control and drive system, but also the key components of conventional spindles through his Siemens contact partner.

¹⁾ In combination with SINAMICS S120 & SINUMERIK.

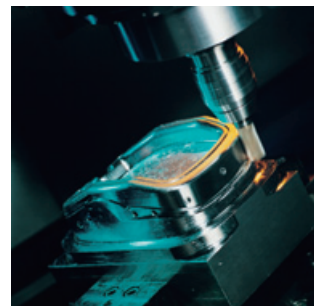
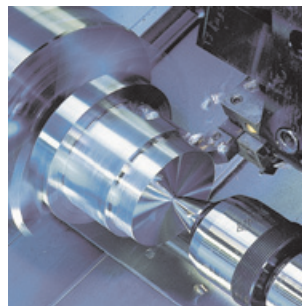

Motors for conventional spindles

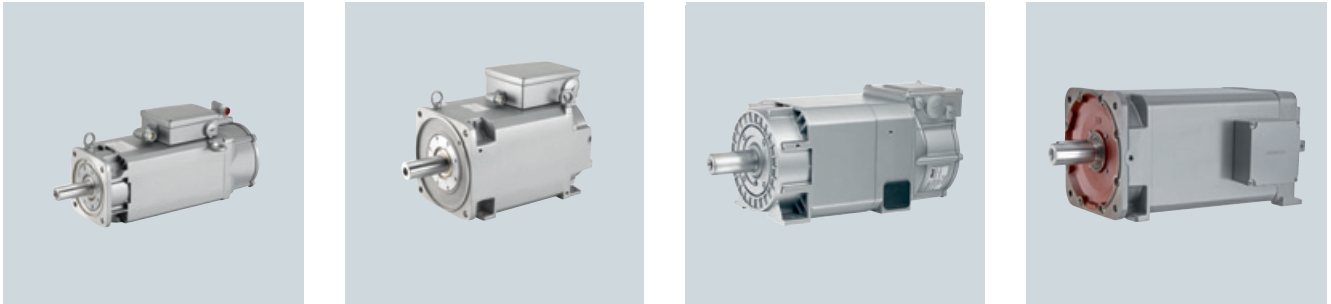

Asynchronous motors for conventional spindles 1PH8 forced-ventilated, 1PH8 water-cooled, 1PH7, 1PH4

1PH8 motors are the new Siemens standard for implementation in conventional machine tool spindles. The compact motors are highly dynamic with excellent concentricity and low vibration. They give machine tool spindles a high degree of precision and help to increase productivity.

With speeds up to 20,000 rpm, power ratings from 2.8 to 300 kW and different versions in terms of protection and cooling type as well as various bearing designs, 1PH8 motors are suitable for a wide range of spindle types.

Integrated encoders maintain constant speed and allow the spindles to be positioned, for example on automatic tool changing.

In addition to the asynchronous variant, 1PH8 motors are also available in highly compact synchronous variants. This further expands the universal implementation possibilities of the motors. With their integral electronic nameplate and digital DRIVE-CLiQ system interface, they are optimized for operation with the SINAMICS S120 drive system.

Motors for belt-driven spindles

For belt-driven machine-tool spindles, 1PH8 motors with solid shafts for mounting the belt wheel are used.

The forced-ventilated 1PH7 motors and the 1PH4 motors are also available for belt-driven spindles.

Motors for coupled spindles

For spindles in which the spindle and motor are directly coupled, 1PH8 motors are available in a variant with a hollow shaft, so that lubricating coolant can be transported from the back of the motor to the tool through a rotary feed-through.

1PH8 motors with solid shafts are available in the power range from 2.8 to 29 kW.

Applications

- Drive for belt-driven spindles
- Drive for directly coupled spindles in
 - Milling machines
 - Drilling machines
 - Turning machines
 - Grinding machines

Benefits and characteristics

- Compact motors
- Broad power spectrum
- High acceleration capability
- Wide torque spectrum
- Highly versatile thanks to a wealth of different mechanical versions and options.
- Ideally suited for use with the SINAMICS S120 drive system
 - Reliable, targeted configuration with SIZER
 - Easy commissioning due to electronic nameplate and DRIVE-CLiQ interface

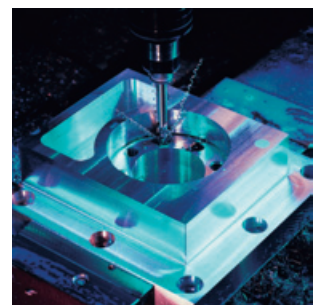

Motors for conventional spindles

Overview

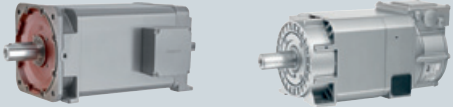
Technical data	Asynchronous motors with solid/hollow shaft		Asynchronous motors with solid shaft	
				
Motor series	1PH8		1PH4	1PH7
Cooling method	Forced ventilation	Water cooling	Water cooling	Forced ventilation
Shaft height (SH)	80 ... 132	80 ... 280	100 ... 160	100 ... 280
Degree of protection	IP55	IP55/IP65	IP55/IP65	IP55/IP65
Design	SH 80/100/132: IM B3, IM B5 SH 100/132: IM B35	SH 80/100/132: IM B3, IM B5 SH 100/132: IM B35 SH 180/225/280: IM B3, IM V5, IM B5, IM B35, IM V15	IM B35 (IM V15, IM V36)	IM B3 (IM V5, IM V6), IM B5 (IM V1, IM V3), only SH 100 and SH 132, IM B35 (IM V15, IM V35)
Line voltage	400 ... 480 V		400 ... 480 V	400 ... 480 V
Rated power P_{rated}	2.8 ... 29 kW		3.7 ... 300 kW	7.5 ... 52 kW
Rated speed n_{rated}	1,000 ... 5,000 rpm		1,500 ... 2,000 rpm	400 ... 2,900 rpm
Rated torque M_{rated}	10 ... 162 Nm		45 ... 333 Nm	22 ... 2,480 Nm ¹⁾
Overload capability	> 2 x M_{rated} for a short time			
Max. speed n_{max}	up to 20,000 rpm		up to 12,000 rpm	up to 12,000 rpm
Connection method	Connector for signals or DRIVE-CLiQ interface; Terminal box NDE ²⁾ top/power connector	Connector for signals or DRIVE-CLiQ interface SH 80 to SH 132: Terminal box NDE ²⁾ top/power connector SH 180 to 280 SH: Terminal box NDE ²⁾ top	Signal connection via connectors or DRIVE-CLiQ interface Power connection via terminal box	
Insulation of stator winding	Temperature class F for ambient temperature from -15 °C to +40 °C	SH 80 to 132: Temperature class F for ambient temperature of -15 °C to +40 °C SH 180 to SH 280: Temperature class H	Temperature class 155 (F) for coolant inlet temperature up to 30 °C	Temperature class 155 (F) for ambient temperature up to 40 °C
Sound pressure level (tolerance + 3 dB)	70 dB(A) at rated pulse frequency of 4 kHz	SH 80 to SH 132: 68 dB(A) at rated pulse frequency of 4 kHz SH 180 to SH 225: 70 dB(A) at rated pulse frequency of 2/4 kHz SH 280: 72 dB(A) at rated pulse frequency of 2/4 kHz	69 to 71 dB(A) depending on shaft height	70 to 76 dB(A) with 50 Hz fan operation, depending on shaft height and direction of air flow
Built-in encoder systems, with/without DRIVE-CLiQ interface	Incremental encoder sin/cos 1 V_{pp} 256/512/2048 pulses/revolution Absolute encoder EnDat 2048 pulses/revolution (Single-turn) or 4096 drives (Multiturn)		Incremental encoder sin/cos 1 V_{pp} 2048 pulses/revolution, Absolute encoder EnDat 2048 pulses/revolution	
Mounted gearing/gear ratio	On request			
Siemens drive system	SINAMICS S120		SINAMICS S120, SIMODRIVE 611	
Tools				
• SINAMICS configuration	SIZER	SIZER	SIZER	SIZER
• SIMODRIVE configuration	–	–	SIDIM/NCSD	SIDIM/NCSD
• CAD data	CAD Creator	CAD Creator	CAD Creator	CAD Creator

¹⁾ In combination with SINAMICS S120 & SINUMERIK.

²⁾ NDE: Non Drive End

Motors for conventional spindles

Variants of the 1PH8 motors at a glance

Our product range – what we have to offer									
Shaft height	Rated power S1	Rated torque range S1	Rated speeds	Maximum speeds	Motor type	Edge dimension	Flange diameter	Motor shaft diameter	Motor shaft length
<i>h</i>			<i>n_{rated}</i>	<i>n_{rated}</i>		<i>b</i>	<i>f</i>	<i>d_{shaft}</i>	<i>L_{shaft}</i>
mm	kW	Nm	rpm	rpm		mm	mm	mm	mm
1PH8 forced-ventilated									
80	2.8 ... 5.8	10 ... 24	1,500 ... 4,500	20,000	1PH808...	155	200	32	80
100	3.7 ... 11	23 ... 60	1,000 ... 5,000	18,000	1PH810...	196	250	38	80
132	11 ... 29	28 ... 162	1,000 ... 5,000	15,000	1PH813...	260	250	48	110
1PH8 water-cooled									
80	3.5 ... 8.5	14 ... 29	1,500 ... 4,500	20,000	1PH808...	155	200	32	80
100	6.4 ... 14	31 ... 89	1,500 ... 2,000	12,000	1PH810...	196	250	38	80
132	15 ... 29	86 ... 140	1,500 ... 2,000	15,000	1PH813...	260	250	48	110
180	17 ... 120	405 ... 615	400 ... 2,500	7,500	1PH818...	384	450	65	140
225	36 ... 226	832 ... 1,122	400 ... 2,500	5,500	1PH822...	474	550	75	140
280	71 ... 215	1,643 ... 2,598	400 ... 1,500	3,300	1PH828...	588	660	95	170

Variants of the 1PH7/1PH4 motors at a glance

Our product range – what we have to offer												
Shaft height	Rated power S1	Rated torque range S1	Rated power S6-40%	Rated torque range S6-40%	Rated speeds	Maximum speeds	Motor type		Edge dimension	Flange diameter	Motor shaft diameter	Motor shaft length
<i>h</i>					<i>n_{rated}</i>	<i>n_{rated}</i>		<i>L</i>	<i>b</i>	<i>f</i>	<i>d_{shaft}</i>	<i>L_{shaft}</i>
mm	kW	Nm	kW	Nm	rpm	rpm		mm	mm	mm	mm	mm
1PH7 forced-ventilated												
100	3.7 ... 10.5	23.6 ... 59.7	5.25 ... 14.5	33.5 ... 84	1,000 ... 2,000	up to 12,000	1PH710	411 ... 529	196	180	38	80
132	11 ... 28	70 ... 162.3	16.5 ... 43	105 ... 238.7	1,000 ... 2,000	up to 10,000	1PH713	538 ... 646	260	250	42	110
160	12 ... 41	171.9 ... 305.5	18 ... 61	248.3 ... 458.2	500 ... 2,000	up to 8,000	1PH716	640 ... 723	314	300	55	110
180	21.5 ... 85	298 ... 565	30.5 ... 126	439 ... 820	500 ... 1,750	up to 7,000	1PH718	835 ... 925	360	300 / 350	60 / 65	140
225	55 ... 205	636 ... 1,080	75 ... 303	865 ... 1,595	700 ... 2,500	up to 5,500	1PH722	1100 ... 1280	450	450	75	140
280	80 ... 270	1,228 ... 2,286	118 ... 397	1,806 ... 3,648	500 ... 1,750	up to 3,300	1PH728	1146 ... 1386	560	550	95	170
1PH4 water-cooled												
100	7.5 ... 14	48 ... 90	10 ... 18.75	64 ... 120.5	1,500	up to 12,000	1PH410	416 ... 541	190	180	38	80
132	15 ... 30	95 ... 190	21 ... 42	133 ... 266	1,500	up to 10,000	1PH413	458 ... 578	246	250	42	110
160	37 ... 52	235 ... 331	52.5 ... 73	333.4 ... 464.6	1,500	up to 8,000	1PH416	591 ... 691	290	300	55	110

Externally driven spindles



Externally driven spindles

Overview

The externally driven spindle is a belt-driven, water-cooled unit that offers the optimum price/performance ratio for machine tools in the lower to medium power range.

With the help of an air barrier, the mechanical spindle has degree of protection IP64 on the drive end.

The integrated precision spindle bearings in a rigid bearing arrangement enable high spindle rigidity and excellent axial and radial runout. Automatic relubrication of the bearings enables a max. spindle speed of 15,000 rpm to be achieved. The bearing service life is also lengthened considerably.

This rigid bearing arrangement increases the quality of the machined workpiece surface.

Applications

Machine tools for

- Milling
- Drilling

Benefits and characteristics

- Long or short spindle nose
- Spindle with belt pulley
- Tool holder universal ISO 40 standard taper with SK40 interface
- Tool clamping with force-controlled cup-spring assembly
- Max. speed up to 15,000 rpm
- Automatic relubrication of bearings
- Precision spindle bearings for maximum accuracy
- Max. torque up to (S1) 80 Nm¹⁾ / 140 Nm²⁾
- Max. power up to (S1) 15 kW¹⁾ / 27 kW²⁾
- Max. radial and axial machining forces depending upon optional bearing arrangements and load ratios $F_{\text{radial}} / F_{\text{axial}}$ on drive end

Options

- Tool holder universal ISO 40 standard taper for CAT40 / BT40/30° / BT40/45° interface
- Tool release mechanism: Hydraulic for reduced tool changeover times and digital detection of tool clamping status
- Rotary feed-through for internal tool cooling up to 70 bar and 50 l/min.
- Bearing arrangement on drive end:
 - 2 bearings
 - 4 bearings

¹⁾ 2 bearings on drive end (side A)

²⁾ 4 bearings on drive end (side A)



Spindle with belt pulley

... with automatic relubrication

... also with release mechanism

... also with rotating union

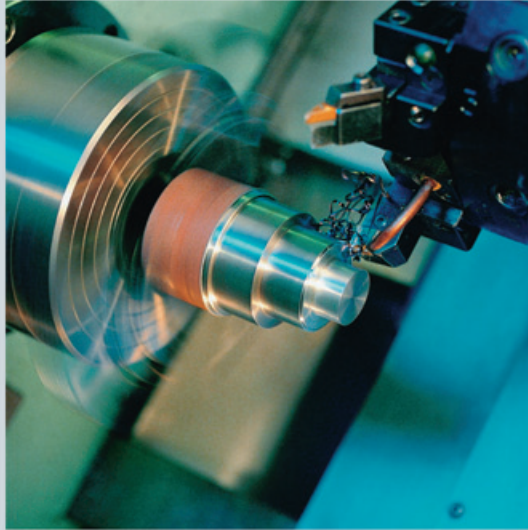

Turning technology



Production of turbine blades



Grinding technology

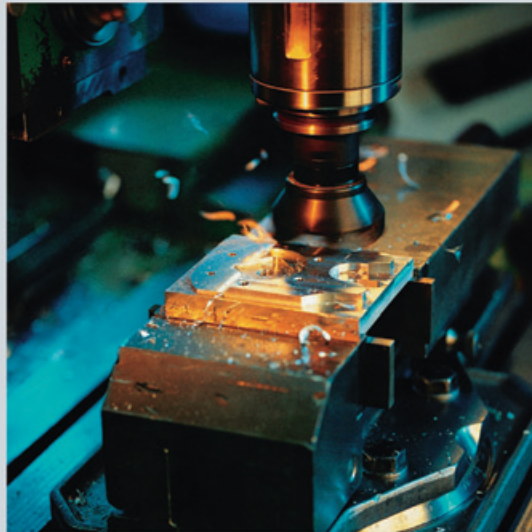

Milling technology – model building



SINUMERIK operator panel with machine control panel

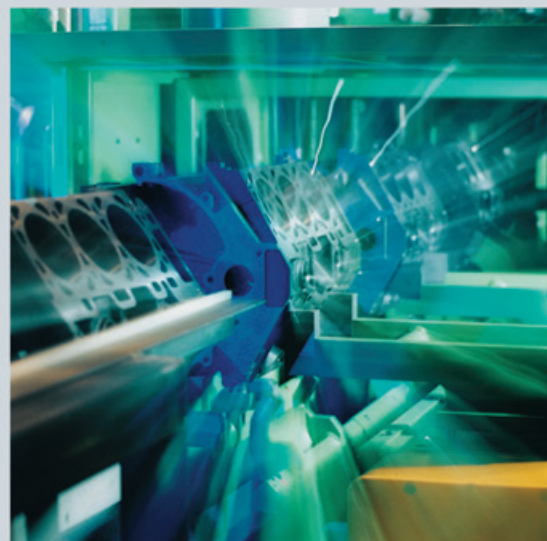

Automotive industry

Built-in motors and motor spindles

With the trend toward greater productivity and more compact machine design, the use of integrated motor spindles is becoming more and more commonplace. Their dynamic rigidity and low vibration tendency make a further leap in

machining quality possible. Their ability to accelerate and operate at high speeds shortens the machining time, thereby increasing the productivity of the machine as a whole.

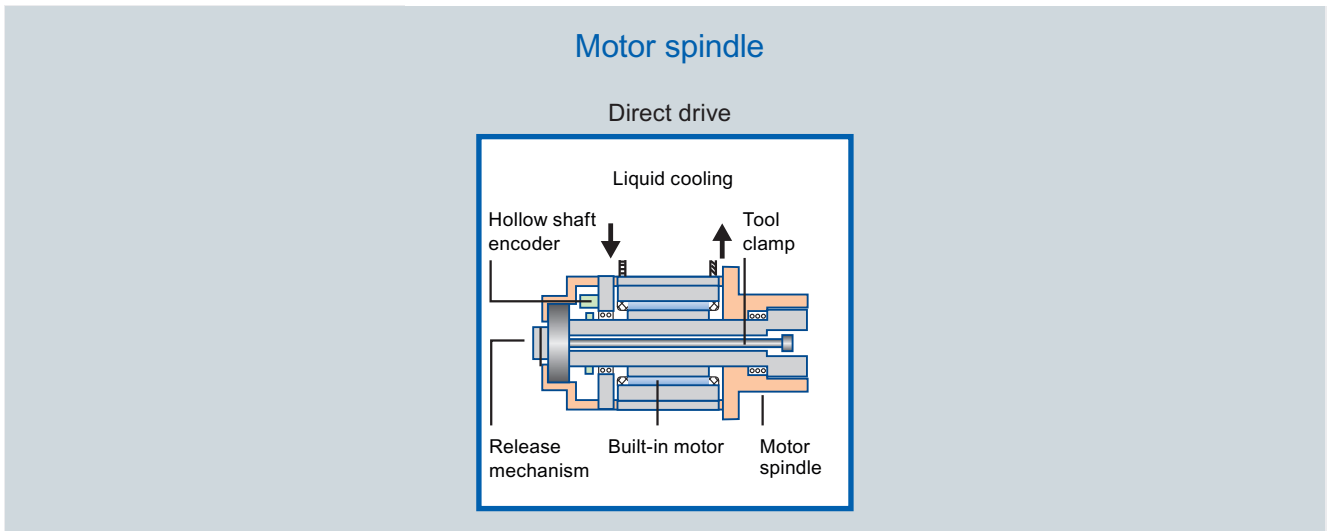

Schematic diagram of a motor spindle

The Siemens range includes both complete motor spindles for milling, turning and grinding applications and built-in motors for motor spindles.

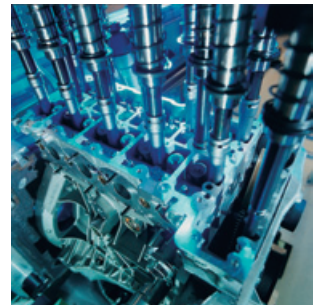
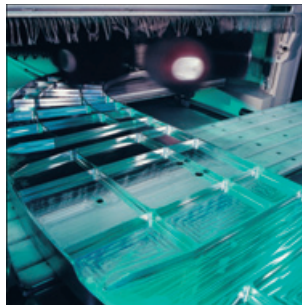

Motor spindles are the preferred choice for extremely demanding precision applications

Built-in motors for spindles



1PH2 built-in asynchronous motor

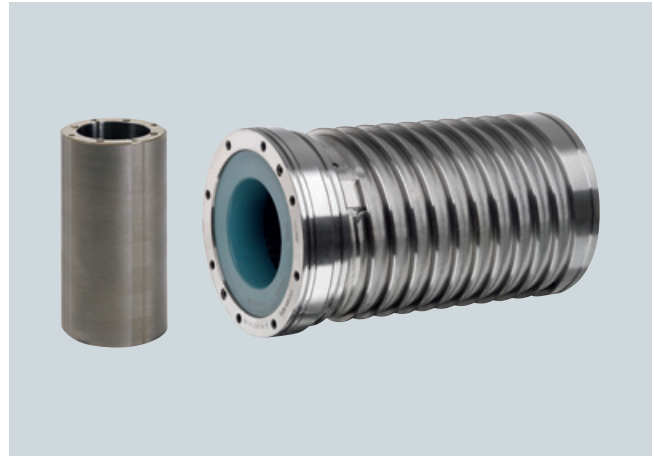

1FE1 synchronous built-in motor

Overview

Users who produce their own motor spindles can obtain the right built-in motor from Siemens. These motors are characterized by their compact design, ruggedness, superior precision and accuracy.

Siemens offers three different types of built-in motors for motor spindles:

- The 1PH2 built-in asynchronous motor is employed as a compact, standard built-in motor for lathe and grinding-wheel spindles with maximum speeds of up to 10,000 rpm.
- The "High Torque" version of the 1FE1 motor is characterized by maximum torques, and achieves peak speeds of 20,000 rpm.
- The "High Speed" version of the 1FE1 motor is characterized by extremely short acceleration times, and achieves peak speeds of up to 40,000 rpm.

Principle of operation, design

The 1PH2 motor is asynchronous. The rotor, which is of the squirrel-cage type, and the stator, which is equipped with coils, are delivered as components, which the engineer combines to form a motor spindle that he then installs in the machine.

The same applies to 1FE1 motors. However, unlike the 1PH2 version, they are synchronous, with a rotor that is equipped with permanent magnets.

With all these motors, water cooling is used to dissipate the heat. The position is sensed by external encoders, and most commonly with a hollow shaft measuring system.

Benefits and characteristics

Since mechanical power transmission elements (belt, gearing) and the resulting backlash are dispensed with, built-in motors boast the following characteristics:

- Excellent quality of surface finish
- High acceleration capability
- High rigidity thanks to compact design
- Free of wear
- High efficiency

Applications

Our built-in motors are ideal for use in motor spindles for machine tools:

- 1PH2 motors for grinding-wheel and lathe spindles
- 1FE1 motors for lathe, grinding-wheel and milling spindles

Built-in motors for standard and high-performance spindles

Technical data	Built-in asynchronous motors	Built-in synchronous motors for high torque and high speed applications	
			
Motor series	1PH2	1FE1	1FE1
Version		High Torque	High Speed
Cooling method	Water cooling	Water cooling	
Stator diameter D_A	180 and 220	85 ... 280	106 ... 240
Degree of protection	IP00 or as stated by spindle manufacturer	IP00 or as stated by spindle manufacturer	
Design	Delivered as components	Delivered as components	
Line voltage	400 ... 480 V	400 ... 480 V	
Rated power P_{rated}	7.5 ... 31 kW	4 ... 104 kW	6 ... 94 kW
Rated speed n_{rated}	1,500 rpm	750 ... 15,800 rpm	2,000 ... 25,000 rpm
Rated torque M_{rated}	48 ... 197 Nm	up to 820 Nm	up to 300 Nm
Overload capability	285 Nm (S6-25%)	1,240 Nm (S6-25%)	465 Nm (S6-25%)
Max. speed n_{max}	up to 10,000 rpm	up to 20,000 rpm With field weakening	up to 40,000 rpm With field weakening
Connection method	Free cable ends	Free cable ends	
Insulation of stator winding	Temperature class 155 (F) for coolant inlet temperature up to 25 °C	Temperature class 155 (F) for coolant inlet temperature up to 25 °C	
Sound pressure level (tolerance + 3 dB)	Depending on spindle design	Depending on spindle design	
Integrated encoder systems	External encoder, depending on machine design		
Siemens drive system	SINAMICS S120, SIMODRIVE 611		
Typical applications	Motor spindles in machine tools, e.g. turning and grinding machining centers	Motor spindles in machine tools requiring high torques, e.g. turning and grinding machining centers	Motor spindles in machine tools requiring high speeds, e.g. grinding and milling machining centers
Tools			
• SINAMICS configuration	–	SIZER	SIZER
• SIMODRIVE configuration	SIDIM/NCSD	SIDIM/NCSD	SIDIM/NCSD
• CAD data	–	CAD Creator	CAD Creator

Built-in motors for spindles

Variants of the 1PH2 at a glance.

Our product range – what we have to offer										
Rated power S1	Rated torque range S1	Rated power S6-40%	Rated torque range S6-40%	Rated speeds	Maximum speeds	Motor type	L	D	D_A	d_i
kW	Nm	kW	Nm	n_{rated} rpm	n_{rated} rpm		mm	mm	mm	mm
7.5 ... 13	48 ... 83	9 ... 15.4	57 ... 98	1,500	up to 10,000	1PH209	250 ... 300	205	180	67
15.1 ... 31	95 ... 197	19 ... 38.6	119 ... 245	1,500	up to 10,000	1PH211	290 ... 390	250	220	82

Dimension drawing

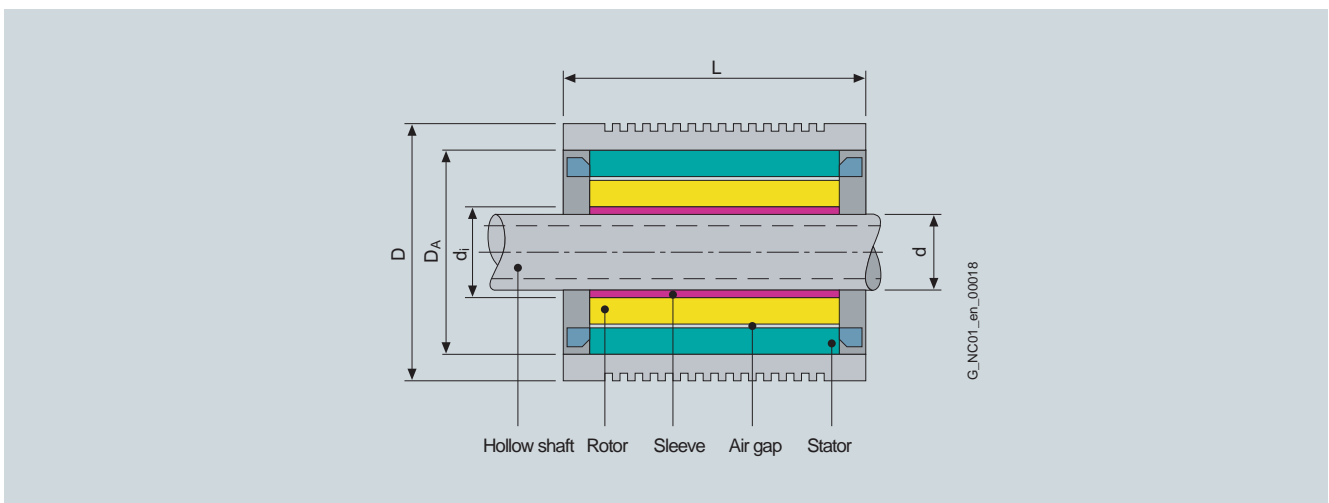

Variants of the 1FE1 at a glance.

Our product range – what we have to offer										
Rated power S1	Rated torque range S1	Rated power S6-40%	Rated torque range S6-40%	Rated speeds	Maximum speeds	Motor type	L	D	D_A	d_i
kW	Nm	kW	Nm	n_{rated} rpm	n_{rated} rpm		mm	mm	mm	mm
High Speed series										
6.5 ... 31.4	5 ... 20	8 ... 35	7 ... 27	7,900 ... 25,000	up to 40,000	1FE105	130 ... 230	120	106	46
14 ... 48	28 ... 60	16 ... 51	40 ... 86	3,200 ... 9,700	up to 24,000	1FE107	185 ... 285	155	135	58
8.8 ... 38	42 ... 105	8.8 ... 38	55 ... 140	2,000 ... 4,300	up to 20,000	1FE108	190 ... 340	180	160	68
10.5 ... 52	24 ... 150	10.5 ... 52	35 ... 206	1,800 ... 4,500	up to 18,000	1FE109	200 ... 400	205	180	72/80
25 ... 72.6	102 ... 204	30 ... 85	142 ... 270	1,200 ... 3,800	up to 16,000	1FE110	265 ... 415	230	200	96
63 ... 94	200 ... 300	75 ... 112	275 ... 410	2,000 ... 3,000	up to 14,000	1FE112	315 ... 415	270	240	110
High Torque series										
7.4 ... 14.4	4.5 ... 11	10 ... 18	6 ... 14	10,000 ... 15,800	20,000	1FE104	107 ... 157	95	85	44/-
6.3 ... 23	10 ... 37	7.9 ... 29	12.6 ... 46	6,000 ... 8,000	up to 15,000	1FE105	170 ... 320	115	103.5	42/33
4 ... 25	13 ... 56	5.3 ... 36.5	17 ... 81	3,000 ... 8,500	up to 12,000	1FE106	130 ... 280	130	118	58/48
15 ... 34	65 ... 130	18.7 ... 42	81 ... 175	1,100 ... 5,000	up to 9,000	1FE108	195 ... 295	190	170	93/67/ 74, 80
6.3 ... 36.6	28 ... 100	7.5 ... 47	36 ... 128	1,600 ... 3,500	up to 7,000	1FE109	150 ... 250	205	180	92/67/ 80
22 ... 41.9	150 ... 300	24 ... 53	190 ... 384	700 ... 2,100	up to 6,500	1FE111	260 ... 410	250	220	120/82/ 102/105
63 ... 104	430 ... 820	80 ... 124	620 ... 1,110	750 ... 1,700	8,000	1FE114	340 ... 490	310	280	166.7/ 150.3

All the stated information is based on S1 operation

Dimension drawing

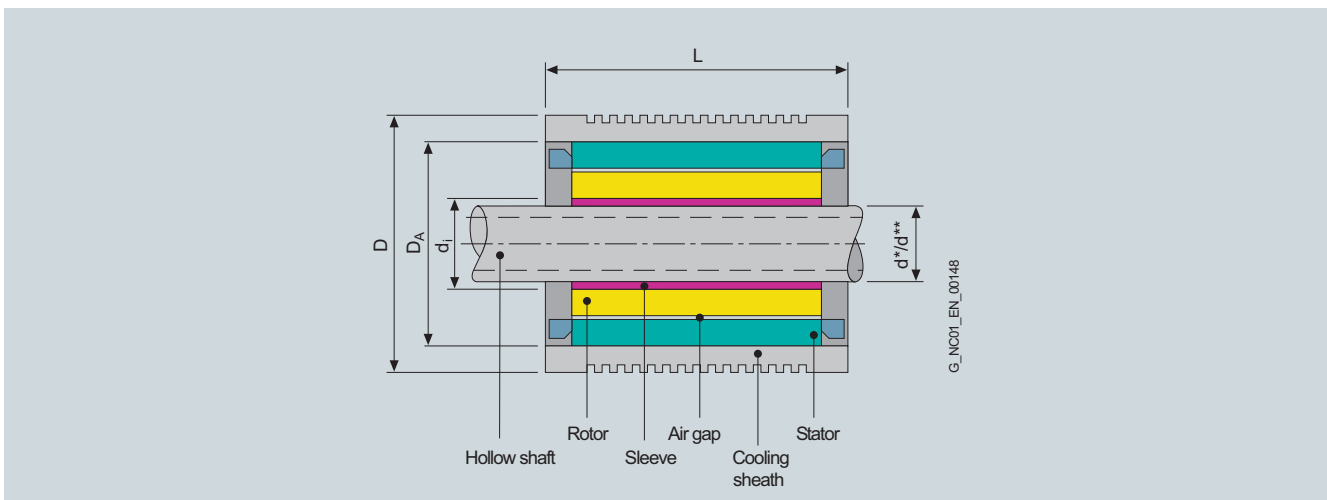

Motor spindles

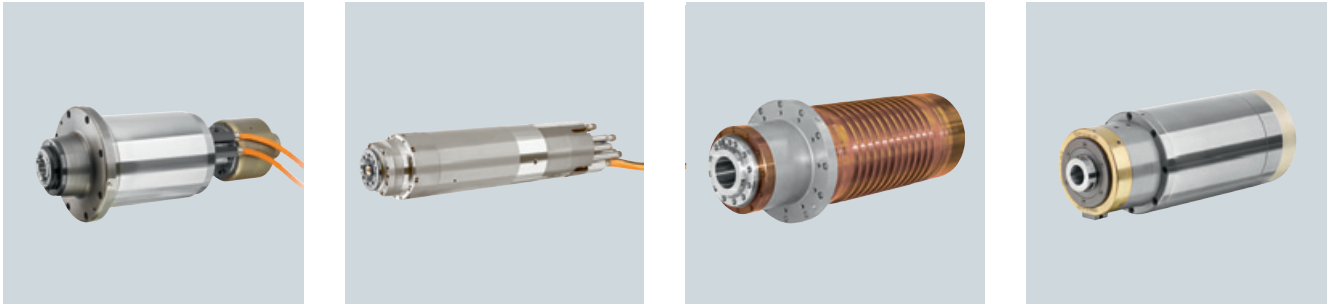

Motor spindles for milling, turning and grinding

Overview

As well as spindle motors in various designs, Siemens also offers complete motor spindles.

Our modular range of motor spindles covers the milling, drilling, turning and grinding machining techniques, so that here, too, a tailor-made solution can be designed for virtually every application. All our expertise in the field of motor spindles is concentrated in our 100%-owned subsidiary, Weiss Spindeltechnologie GmbH, a leading supplier of motor spindles. In addition to the preferred and listed spindles described here for milling, turning and grinding, the experts at Weiss Spindeltechnologie GmbH also design and manufacture individual spindle solutions. These can be designed and made available with a power range of up to 130 kW and up to 1,250 Nm without gear, or up to 3,280 Nm with integrated gear.

The spindles are available in synchronous and asynchronous technology.

All the components of our motor spindles – bearings, sensors, cooling, clamping mechanism, etc., are perfectly matched and pretested.

The design of Weiss motor spindles enables the maximum degree of ruggedness. What's more, it ensures fast integration in the machine and problem-free commissioning.

Benefits and characteristics

- Excellent quality of surface finish, maximum concentricity and high dynamic rigidity
- Short acceleration times and high maximum speeds
- Compact design
- Flexible adaptation to user requirements thanks to various tool and workpiece clamping systems
- Easy installation and commissioning due to self-contained system unit
- Easy installation with defined interfaces for mechanics, cooling, electrics and hydraulics/pneumatics.
- Ideally suited for use with the SINAMICS S120 and SIMODRIVE 611 drive systems

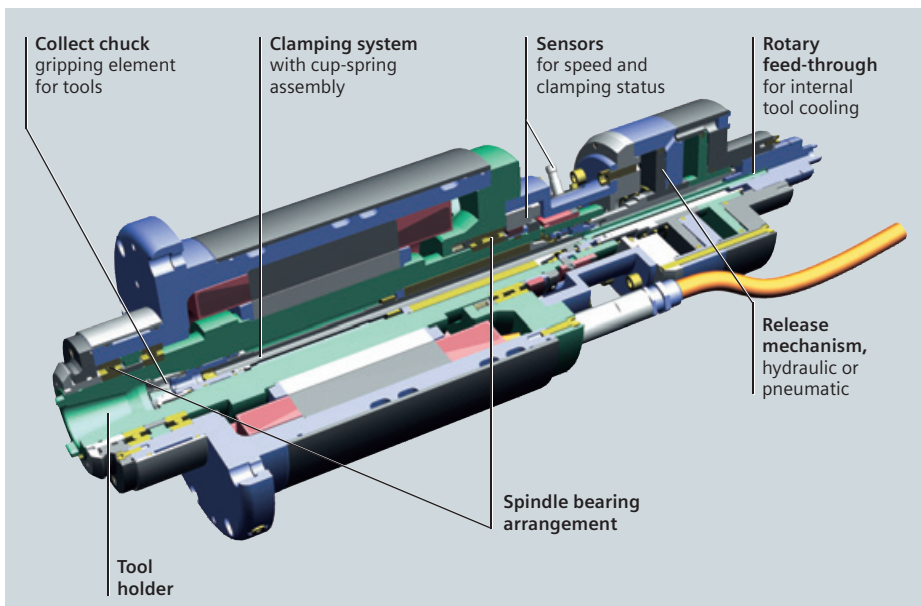

Problem-free commissioning is assured by standardized interfaces to the spindles for media and signal connections, and by system tests conducted in advance at Weiss.

Standard motor milling spindles – 2SP1 series

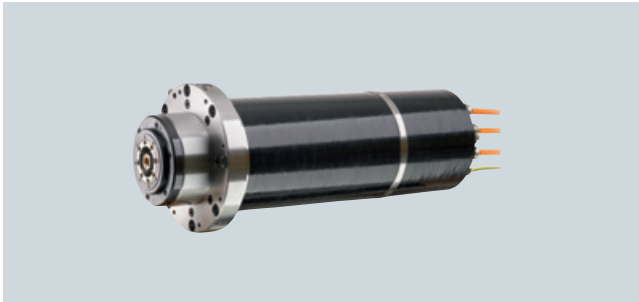

2SP120 standard motor milling spindle

Standard motor milling spindles from the 2SP1 series are motor spindles that can be ordered from our catalog. They are designed for high torques and can therefore be used for both roughing and finishing.

Different levels of performance with torques ranging from 42 to 170 Nm and maximum speeds from 10,000 to 18,000 rpm are available, with two different diameter sizes.

They represent the ideal drive solution for main spindles in standard milling machines and machining centers, and boast the following characteristics:

- The complete solution is comparable with belt-driven solutions and more economical than the classical customized motor spindle designs

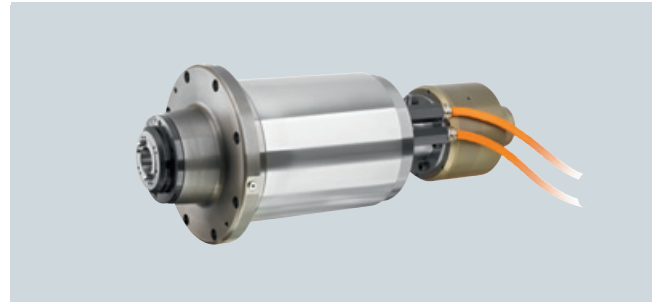

2SP125 standard motor milling spindle

- Hydraulic or pneumatic tool clamping and release mechanism depending on user preference
- Thanks to the pneumatic tool clamping and release mechanism, no hydraulic unit is required
- Integrated analog and digital sensors (for indexing and monitoring tool change)
- Worldwide supply of complete systems, including mechanical spindle components, from a single source
- Higher speed and shorter acceleration time compared to conventional solutions

Options

- Available with HSK A63, SK40, CAT40 and BT40 tool interfaces
- Choice of internal or external tool cooling

The entire 2SP1 series spectrum

Order No.	Rated power	Rated torque	Rated speed	Rated current	Rated power	Rated torque	Rated power	Rated torque	Rated speed	Rated current	Maximum speed
	S1 kW	S1 Nm	rpm	S1 A	S6-40% kW	S6-40% Nm	S1 kW	S1 Nm	rpm	S1 A	rpm
Synchronous	Star operation				Delta operation						
2SP1202-1HA-1DF2	12.0	42	2,700	30	12.0	55					15,000
2SP1202-1HB-2DF2	15.5	42	3,500	42	15.5	55					18,000
2SP1204-1HA-1DF2	26.4	84	3,000	60	26.4	110					15,000
2SP1204-1HB-2DF2	35.0	78	4,300	79	35.0	110					18,000
Asynchronous											
2SP1253-8HA0-0-2	13.2	70	1,800	28	18.9	100	13.2	32	4,000	29	10,000
2SP1253-8HA0-1D-2	13.2	70	1,800	28	18.9	100	13.2	32	4,000	29	15,000
2SP1255-8HA0-0-2	11.7	140	800	30	16.7	200	11.7	62	1,800	29	10,000
2SP1255-8HA0-1D-2	11.7	140	800	30	16.7	200	11.7	62	1,800	29	15,000
Synchronous											
2SP1253-1HA0-0-2	26.0	100	2,500	53	29.0	130					10,000
2SP1253-1HB0-1D-2	35.0	100	3,300	68	38.0	130					15,000
2SP1255-1HA0-0-2	46.3	170	2,600	95	55.0	236					10,000
2SP1255-1HB0-1D-2	53.4	170	3,000	120	64.0	236					15,000

Compact milling spindles from the F series

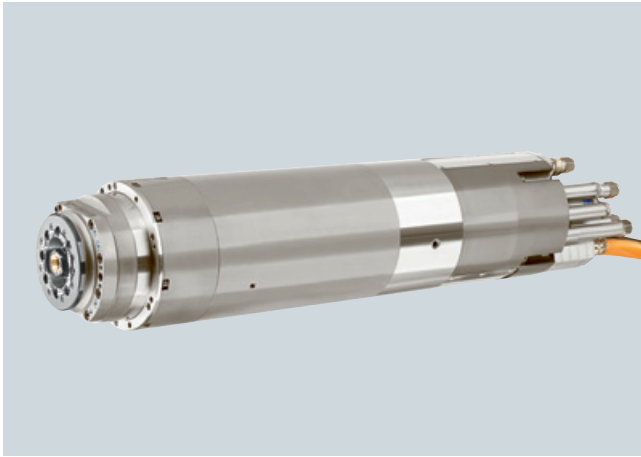

F1xx compact milling spindle

Motor spindles from the F series are available for a power range of 11 to 80 kW (S1 operation) and rated torques of up to 300 Nm.

They are available in both synchronous and asynchronous technology, and are especially noted for their compact design. With a maximum speed of 40,000 rpm, they satisfy the requirements of typical, high-performance milling spindles in typical high-speed applications.

Performance features

- Tool holder:
 - HSK in all the usual sizes
 - Optional ISO for adapted speeds
- Taper and end face cleaning:
 - Filtered compressed air in the taper and on the end face for keeping the tool interface clean and ensuring constant accuracy
- Bearing lubrication:
 - Lifetime grease lubrication
 - Oil/air minimum quantity lubrication
- Bearing temperature monitoring:
 - PT100 or PT1000
- Seal on drive end:
 - Labyrinth seal with air barrier
- Motor temperature monitoring with KTY84 and PTC
- Tool clamp:
 - Tool clamping using a force-controlled cup-spring assembly
- Tool release mechanism:
 - Hydraulic for minimized tool changeover times, optional installation of pneumatic cylinders
- Sensors for tool clamping status:
 - Analog or digital
- Rotary feed-through:
 - Lubricant up to 80 bar, minimum quantity lubrication and dry machining possible without modification

Options

- Sensor for axial spindle growth:
 - Direct feedback for length compensation in the machine
- Acceleration sensor:
 - For sensing and monitoring the occurring acceleration to protect the spindle

Overview of F series variants for milling

ASYNCHRONOUS VERSION				Tool interface DIN 68 893-1	SYNCHRONOUS VERSION				
Spindle No.:	Diameter	Max. speed	Rated power S1-100% kW		Rated power S1-100% kW	Max. speed rpm	Diameter mm	Spindle No.:	
	mm	rpm							
F150A.30.18	150	30,000	18	◀ E40 ▶	11	30,000	150	F150S.30.11	
F150A.40.18	150	40,000	18						
F170A.18.46	170	18,000	46	◀ A63 ▶	29	18,000	150	F150S.18.29	
F170A.24.46	170	24,000	46			41	18,000	170	F170S.18.41
F210A.18.18	210	18,000	18			28	18,000	210	F210S.18.28
F210A.24.18	210	24,000	18			28	20,000	210	F210S.20.28
F230A.18.40	230	18,000	40			35	18,000	230	F230S.18.35
F230A.24.40	230	24,000	40						
F230A.30.80	230	30,000	80						
F285A.10.32	285	10,000	32	◀ A100 ▶	78	10,000	285	F285S.10.78	
F285A.15.32	285	15,000	32			78	14,000	285	F285S.14.78

Compact lathe spindles from the D series

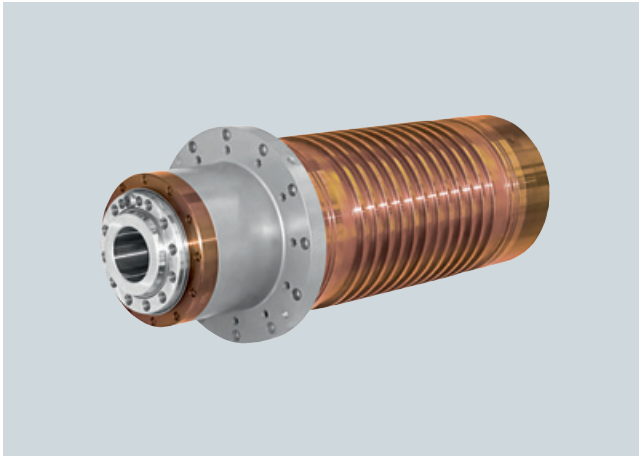

D1xx compact lathe spindle

Motor spindles are purchasable from the D series feature interfaces from sizes A4 to A11 (DIN EN 55026). The spindles are available for a power range up to 104 kW (S1 operation) and rated torques of up to 820 Nm.

They are available in both synchronous and asynchronous technology, and are especially noted for their compact design. With their high concentricity and maximum speeds of up to 10,500 rpm, they satisfy every requirement faced by lathes.

Performance features

- High radial and axial rigidity
- High concentricity
- Seal on drive end:
 - Labyrinth, with optional air barrier
- Connection dimensions:
 - Standard chucks and clamping cylinders
- Constant power range:
 - 1:3 to 1:8
- Motor:
 - Synchronous or asynchronous motors
- Shaft encoder:
 - Integrated
 - Hollow shaft measuring system depending on accuracy requirements and in different reference numbers up to 2048 pulses/revolution $1 V_{pp}$
- Mounting position:
 - Horizontal or vertical, spindle nose at bottom
 - Optional: vertical, spindle nose at top
- Housing:
 - Cartridge with flange
- Motor temperature monitoring with KTY84 and PTC

Options

- Bearing versions (standard, high-speed or hybrid) for different speed classes
- Air barrier

Overview of D series variants for turning

ASYNCHRONOUS VERSION		Interface for power chucks DIN 55026-	SYNCHRONOUS VERSION	
Spindle No.:	Rated torque S1-100% Nm		Rated torque S1-100% Nm	Spindle No.:
D175375-VXXX	85	◀ A4 ▶	100	D175408-VXXX
D175376-VXXX D175374-VXXX	85 140	◀ A5 ▶	100 200	D175409-VXXX D175413-VXXX
D175380-VXXX D175377-VXXX	140 200	◀ A6 ▶	200 300	D175414-VXXX D175410-VXXX
D175378-VXXX	480	◀ A8 ▶	820	D175411-VXXX
D175379-VXXX	750	◀ A11	–	–

Motor grinding spindles from the S series

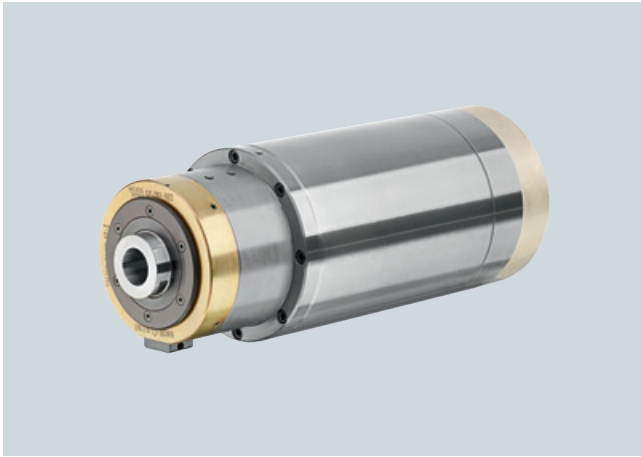

Sxxx motor grinding spindle

Motor spindles from the S series achieve top speeds of up to 80,000 rpm and are therefore ideal for internal cylindrical grinding.

SM/SH spindles have a power range up to 30 kW and rated torques up to 24 Nm.

Performance features

- Tool holder:
 - Cylindrical
- Shaft bearings:
 - Hybrid bearing
- High-precision balancing:
 - Shaft and rotor
 - Dynamic balancing of the mounted spindle
 - Vibration speed $v \leq 1$ mm/s
- Housing:
 - Cylindrical
- Bearing lubrication:
 - Oil/air minimum quantity lubrication
 - Alternatively with lifetime grease lubrication SM (F)
- Seal on drive end:
 - Labyrinth seal assisted by air from oil/air lubrication, or with separate air barrier in the case of greased spindle units SM (F)
- Energy supply:
 - Axial via cover at end of spindle
- Motor:
 - Low-loss asynchronous motors
 - Motor temperature monitoring protection with PTC

Options

- Pulse speed encoder
- Coded plug units

Overview of S series variants for grinding



OIL/AIR LUBRICATION, GREASE LUBRICATION, MEDIUM POWER RANGE

Model No.	Maximum speed rpm	Rated speed rpm	Maximum frequency Hz	Rated frequency Hz	Voltage V	Max. current S1-100% A	Rated power S1-100% kW
SM100-81/74	81,000	74,000	1,350	1,234	350	10	4
SM120-72/60	72,000	60,000	1,200	1,000	350	16	5
SM120-60/51	60,000	51,000	1,000	850	350	21	7
SM120-51/36	51,000	36,000	850	600	350	22	7
SM120-45/36	45,000	36,000	750	600	350	20	9
SM(F)150-24/15	24,000	15,000	400	250	350	28	12
SM(F)150-30/24	30,000	24,000	500	400	350	37	16
SM(F)120-36/24	36,000	24,000	600	400	350	37	16
SM(F)170-18/9	18,000	9,000	600	300	350	50	20

OIL/AIR LUBRICATION, HIGH POWER RANGE

Model No.	Maximum speed rpm	Rated speed rpm	Maximum frequency Hz	Rated frequency Hz	Voltage V	Max. current S1-100% A	Rated power S1-100% kW
SH120-51/45	51,000	45,000	850	750	350	27	9
SH150-40/30	40,000	30,000	667	500	350	37	17
SH150-33/24	33,000	24,000	550	400	350	41	18
SH170-27/18	27,000	18,000	900	600	350	54	20
SH170-21/12	21,000	12,000	700	400	350	74	30

Motor spindles

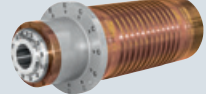
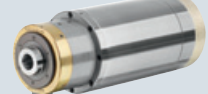
Technical data	Catalog type		Preferred type	
	Standard motor milling spindles, synchronous and asynchronous versions	Compact motor milling spindles, synchronous and asynchronous versions	Motor turning spindles, synchronous and asynchronous versions	Motor grinding spindles for internal cylindrical grinding, asynchronous version
				
Motor series	2SP1 series	F series	D series	S series
Cooling method	Water cooling			
Spindle diameter	200 and 250 mm	150 ... 285 mm	220 ... 442 mm	100 ... 170 mm
Degree of protection	IP64 with purge air on drive end			
Tool/workpiece interface	Tool interface HSK A63 or ISO 40	Tool interface HSK 25 to HSK 100 or ISO 30 to ISO 50	Workpiece interface A4 to A11 acc. to DIN 55026	Tool interface Grinding arbor 12 to 60 mm
System voltage	400 ... 480 V			
Rated power P_{rated}	up to 53.4 kW	up to 80 kW	up to 104 kW	up to 30 kW
Rated speed n_{rated}	Depending on type			
Rated torque M_{rated}	up to 170 Nm	up to 300 Nm	up to 820 Nm	up to 24 Nm
Overload capability	1.5 ... 2 x M_{rated} for a short time	1.5 ... 2 x M_{rated} for a short time	1.5 ... 2 x M_{rated} for a short time	1.5 ... 2 x M_{rated} for a short time
Max. speed n_{max}	up to 18,000 rpm	up to 40,000 rpm	up to 10,500 rpm	up to 80,000 rpm
Connection method	Power supply connection: Free cable lengths Option: Power connector Signal connection via connector		Power supply connection: Power connector Signal connection via connector	
Insulation of stator winding	Temperature class 155 (F) for coolant inlet temperatures up to 25 °C without derating	Temperature class 155 (F) for coolant inlet temperatures up to 25 °C without derating	Temperature class 155 (F) for coolant inlet temperatures up to 25 °C without derating	Temperature class 155 (F) for coolant inlet temperatures up to 25 °C without derating
Sound pressure level (tolerance + 3 dB)	Depending on machine design			
Integrated encoder systems	Incremental encoder sin/cos 1 V_{pp}	Incremental encoder sin/cos 1 V_{pp}	Incremental encoder sin/cos 1 V_{pp}	Optional: Pulse speed encoder on request
Siemens drive system	SINAMICS S120, SIMODRIVE 611			
Typical applications	Main spindles for milling machines		Main spindles for turning machines	Main spindles for grinding machines
Tools				
• SINAMICS configuration	on request	on request	on request	on request
• SIMODRIVE configuration	SIDIM/NCSD	SIDIM	SIDIM	SIDIM
• CAD data	on request	on request	on request	on request

In addition to the preferred and listed types, Weiss Spindeltechnologie GmbH also produces diverse spindle solutions for individual customer requirements. These can be designed with a power range of up to 130 kW and up to 1,250 Nm without gear, or up to 3,280 Nm with integrated gear.

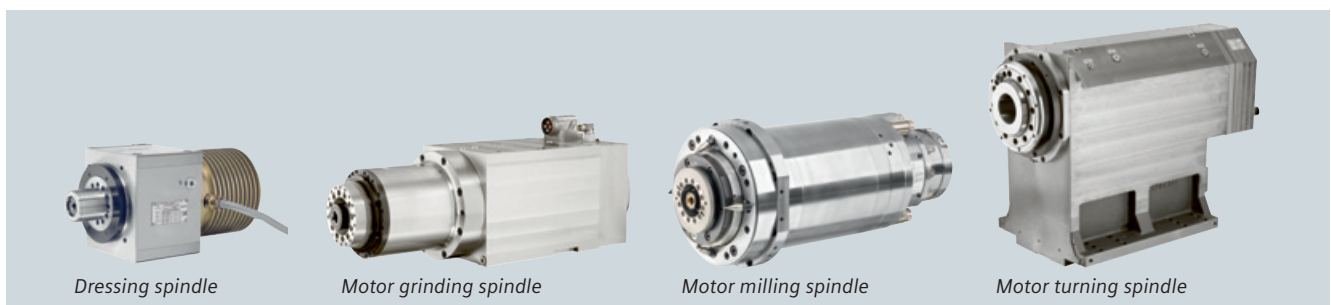

Further information

Further informations about motors:
www.siemens.com/motioncontrol/motors

Ordering on the Internet:
www.siemens.com/automation/mall

Your personal contact – in your area:
www.siemens.com/automation/partner

Service and support:
www.siemens.com/automation/service&support

Partners for your automation solutions
Siemens Automation Solution Provider:
www.siemens.com/automation/solutionpartner

Siemens AG
Industry Sector
Drive Technologies Division
Motion Control Systems
P.O. Box 31 80
91050 ERLANGEN
GERMANY

www.siemens.com/automation

Subject to change
Order No.: 6ZB5411-0BU02-0BA1
3P.8122.52.22 / Dispo 09405
BS 1009 4. VOG 24 En
Printed in Germany
© Siemens AG, 2009

The information provided in this brochure contains descriptions or characteristics of performance which in case of actual use do not always apply as described or which may change as a result of further development of the products.

An obligation to provide the respective characteristics shall only exist if expressly agreed in the terms of contract. Availability and technical specifications are subject to change without prior notice.

All product designations may be trademarks or product names of Siemens AG or supplier companies whose use by third parties for their own purposes could violate the rights of the owners.